

# RNID Sonido Digital Listener

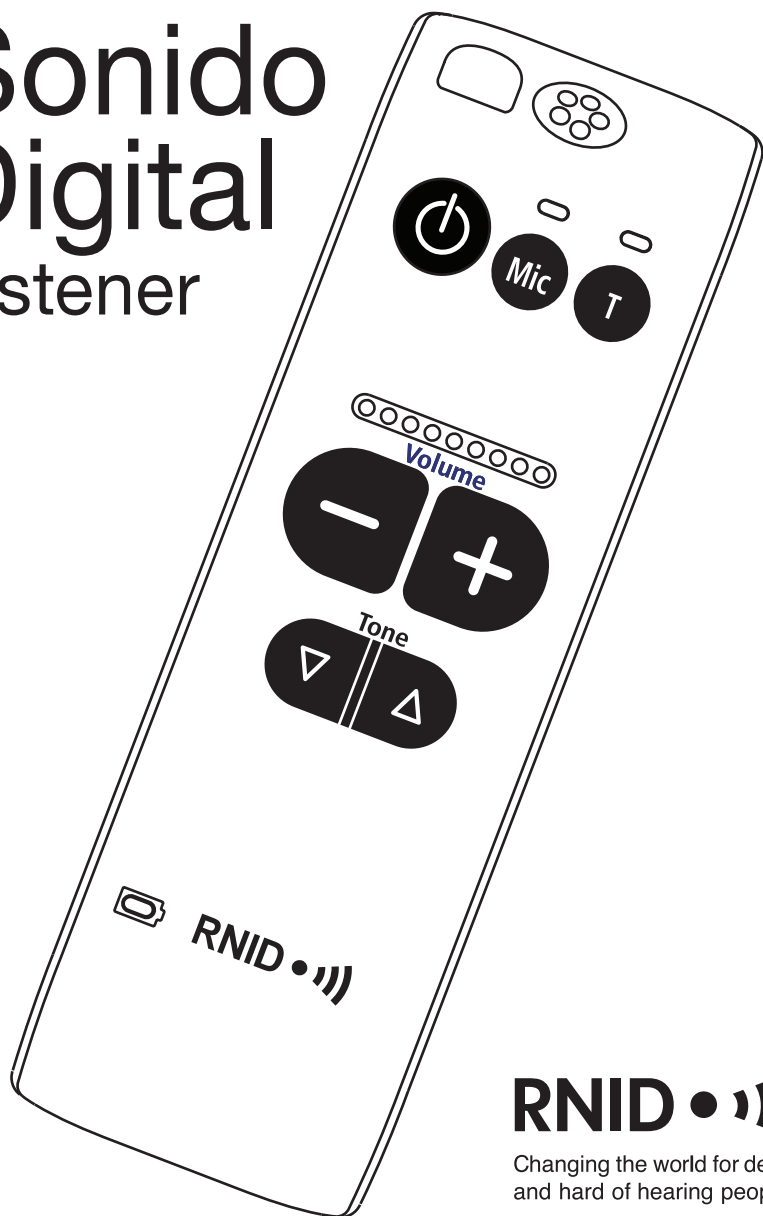

**RNID • )))**

Changing the world for deaf  
and hard of hearing people

## Introduction

Thank you for choosing the RNID Sonido Digital Listener. Sonido uses an advanced digital amplifier so it produces superb sound quality with crystal clear clarity, to improve communication and listening.

Your Sonido has a built in microphone, but you can also listen to sounds by directly connecting\* your listener to televisions and radios. Your Sonido can also be used with a wide range of listening accessories such as headphones, neckloops and ear hooks.

By using different combinations of input and output accessories your Sonido can help in a wide range of listening and conversation tasks, in many different situations.

We hope you enjoy using your Sonido. Please read this instruction leaflet before you use it.

\*Additional accessories may be needed. These can be purchased from RNID Products.

## Precautions

The RNID Sonido Digital Listener is designed solely for deaf and hard of hearing people. If you have a mild hearing loss you can set the maximum volume (see page 7) so that it is loud but not uncomfortable.

Listening to uncomfortable sound levels for prolonged periods could affect your hearing.

Please be aware that this product may include small parts. Ensure that the package and small parts are kept out of reach from children.

## Cleaning

Switch off your Sonido. Gently wipe the product surface using a damp (not wet) cloth. Making sure no moisture gets into the device.

Do not use harsh chemicals, cleaning solvents, or strong detergents to clean your Sonido.

## Inserting batteries



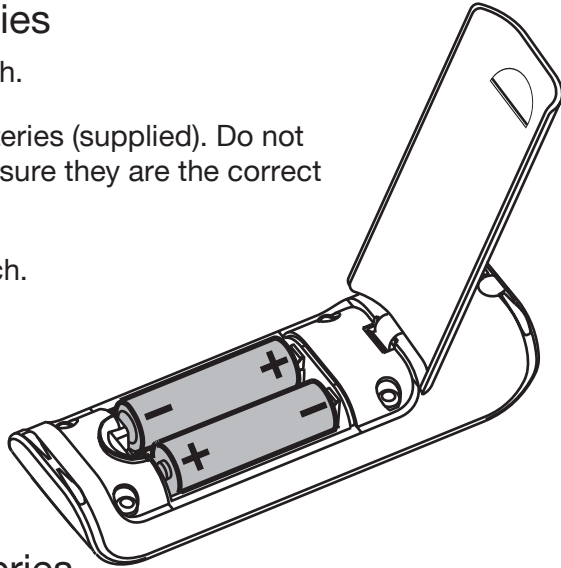

1. Open battery hatch.
2. Insert two AA batteries (supplied). Do not force them. Make sure they are the correct way round.
3. Close battery hatch.





## Replacing batteries

When the batteries are low the  light in the bottom left hand corner will pulse on and off. This indicates you have a few hours of use left. You should replace your batteries soon after you see this light. You can replace them with any standard or rechargeable AA batteries.

## Getting started

1. Put on your listening accessory, (headphones, neckloops etc.) and plug them into the green socket on the right hand side of the product.
2. Press the  button to switch on the device. The lights above the  and  buttons will flash while your Sonido is starting up.
3. The light above the  button will stay on. This indicates that the product is on and that it is using the built in microphone to pick up sound.

The light bar will be partially illuminated for 5 seconds. The light bar shows the volume level – the longer the illuminated section, the higher the volume.



5. Use   buttons to change the volume (see page 5).
6. When finished, press the  button to switch off the device.

## Changing Modes

You can use your Sonido to pick up sound in three different ways:

### Microphone:

A microphone is built into the front of your Sonido. This is ideal for use during conversations.

This microphone is automatically selected when you first turn the product on. You can also change to this mode at any time by pressing the  button. In this mode, the light above the  button will be on. Make sure that nothing is plugged into the front of the device if you want to use this microphone.



### Plug-in sound:

You can also directly connect an external sound input to your Sonido. This is ideal for listening to your television or radio, for example.

Plug-in your connection cable\* into the red socket on the front of the device. Sonido will automatically switch to this input and the built in microphone will switch off. In this mode the light above the  button will be on.



### T-setting:

This setting allows your Sonido to pick up sound from an induction loop. Many public places have induction loops fitted – so look for the  symbol to show where you can use this feature.

Press the  button to select this mode. Sonido will automatically pick up the loop and the built in microphone will switch off. In this mode the light above the  button will be on.

\* Connection cables that allow you to connect your Sonido up to domestic audio equipment are available from RNID Products.

## The Light bar

The light bar above the   buttons can display the volume or tone level, depending on which one you are adjusting. To increase the battery life of your Sonido the light bar will switch off after 5 seconds.

## Changing the volume

You can change the volume by using the   buttons.

To increase the volume, press the  button. The light bar will increase. If the light bar is full then the volume cannot be increased any further.

To lower the volume, press the  button. The light bar will decrease. If there is only one light on then the volume cannot be lowered any further.

For your listening comfort, Sonido will always turn on at a low volume level.

## Changing the tone

You can change the tone by using the   buttons.

To increase the treble, press the  button. A single light in the light bar will move to the right. If the light is at the right hand end of the light bar the treble cannot be increased any further.



To decrease the treble, press the  button. A single light in the light bar will move to the left. If the light is at the left hand end of the light bar the treble cannot be decreased any further.

For your convenience your Sonido will remember your tone settings when you next switch on.

If you are using a neckloop we recommend setting the tone to the middle.

## Conversation mode

The built in microphone is automatically switched off when you connect an external sound input. For Example if your Sonido is connected to a television you will not be able to hear the person sat next to you.

If you want to have a short conversation while you have a plug-in sound input connected, press and hold the  button. You will be able to hear audio from the microphone and the plug-in sound, while the button is pressed. When you release the  button you will return to the plug-in sound, for example your television.

## Belt clip

To fit the belt clip locate the clip on the rear of the device and simply press the wings of the clip into the position shown.

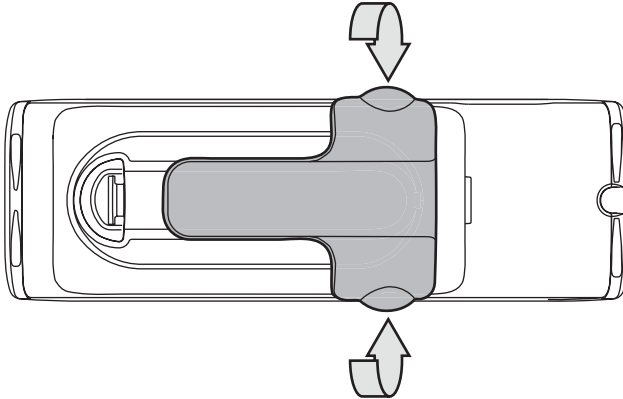

Would you like to know how to adjust the balance, maximum volume and to lock the T mode button? If so read on.

## Advanced settings

1. Open the battery hatch. Do not remove the batteries.
2. Press and hold the settings button, using a small implement such as a pencil, for 5 seconds.

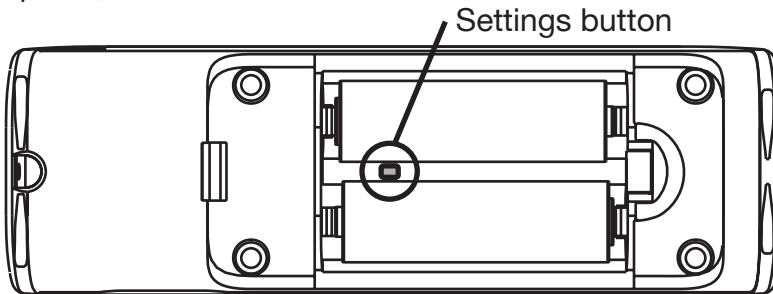



3. You can now adjust the balance between the left and the right ear, by using the **- +** buttons. You cannot adjust the balance if you are using a neckloop. If you do not want to adjust the balance go straight to point 4.

You can increase the volume to the right ear (and decrease the volume in the left ear) by pressing the  button. A flashing light in the light bar will move to the right.

You can increase the volume to the left ear (and decrease the volume in the right ear) by pressing the  button. A flashing light in the light bar will move to the left.

4. Press the settings button.



5. You can now adjust the maximum volume by using the  buttons. If you do not want to adjust the maximum volume go to point 6.



The maximum volume will be lowered by pressing the  button. The light bar will move to the left hand side.

The maximum volume will be increased by pressing the  button. The light bar will move to the right hand side. When there is only one light on the right hand side the maximum volume will not be limited.

6. Press the settings button.

7. You can now adjust the T-setting lock. The T-setting lock disables the T-function. This prevents you switching to T mode accidentally and cutting off the microphone. If you do not want to adjust the T-setting lock go to point 8.

The T-setting lock can be switched on by pressing the  button. The light above the  button will stop flashing.

The T- Setting lock can be switched off by pressing the  button. The light above the  button will start flashing.

8. Press and hold the settings button for 5 seconds to save the settings and leave settings mode. This can be done at any point.

RNID Products is a not-for-profit department of RNID. Our aim is to provide quality equipment to improve the everyday lives of deaf and hard of hearing people. Please contact us for more information about our products.

RNID Products  
1 Haddonbrook Business Centre  
Fallodan Road  
Orton Southgate  
Peterborough  
PE2 6YX  
United Kingdom

Telephone **01733 361199**  
Textphone **01733 238020**  
Fax **01733 361161**

[solutions@rnid.org.uk](mailto:solutions@rnid.org.uk)  
[www.rnid.org.uk/shop](http://www.rnid.org.uk/shop)

**RNID • )))**

Changing the world for deaf  
and hard of hearing people

### **WARRANTY**

There is a 12 month warranty on this product, excluding accessories and batteries supplied with the product. The warranty does not encompass the following: damage due to improper use (incorrect operation by the user, breakages etc), normal wear and tear and defects that have inconsequential effect to the value of the product. The warranty automatically expires if repair measures are undertaken by persons not authorised to do so.



CE - For use in all EU countries

Hereby, Bellman & Symfon, declares that this BE2010 Sonido Digital Listener is in compliance with the essential requirements and other relevant provisions of Directive 1989/336/EEC.

Subjects and technical data for this product can be changed without further notice.